

ZRT100

9.8V LOW POWER PRECISION REFERENCE SOURCE

DESCRIPTION

The ZRT100 is a monolithic integrated circuit providing a precise stable reference voltage of 9.8V at 500 μ A.

The circuit features a knee current of 150 μ A and operation over a wide range of temperatures and currents.

The ZRT100 is available in a SOT223 package for surface mount applications. This device offers a trim facility whereby the output voltage can be adjusted as shown in Fig.1. This facility is used when compensating for system errors or setting the reference output to a particular value. When the trim facility is not used, the pin should be left open circuit.

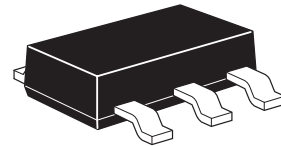

SOT223

FEATURES

- Trimmable output
- Excellent temperature stability
- Low output noise figure
- Available in two temperature ranges
- 1 and 2% initial voltage tolerance versions available
- No external stabilising capacitor required in most cases
- Low slope resistance
- SOT223 small outline package

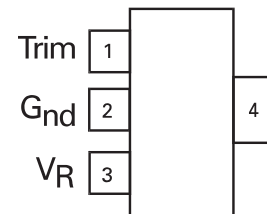

SOT223
Package suffix G
Top view (pin 4 floating or
connected to pin 2)

ORDERING INFORMATION

DEVICE	TOL%	OPERATING TEMP.	PACKAGE	PARTMARK
ZRT100GC2	2	-40 to 85°C	SOT223	ZRT100C2
ZRT100GC1	1	-40 to 85°C	SOT223	ZRT100C1
ZRT100GA1	1	-55 to 125°C	SOT223	ZRT100A1

A grade -55°C to 125°C

C grade -40°C to 85°C

ZRT100

ABSOLUTE MAXIMUM RATINGS

PARAMETER	SYMBOL	LIMIT	UNIT
Reverse current ⁽¹⁾		30	mA
Operating temperature: A grade	T _{OMP}	-55 to 125	°C
C grade		-40 to 85	°C
Storage temperature	T _{STG}	-55 to 150	°C

⁽¹⁾ Above 25°C this figure should be linearly derated to 6mA at 125°C

POWER DISSIPATION (at T_{amb} = 25°C unless otherwise stated)

PACKAGE	VALUE	UNIT
SOT223	2	W

TEMPERATURE DEPENDENT ELECTRICAL CHARACTERISTICS

SYMBOL	PARAMETER	INITIAL VOLTAGE TOLERANCE %	GRADE A		GRADE C		UNIT
			TYP	MAX	TYP	MAX	
ΔV _R	Output voltage change over relevant temperature range(See note (a))	1 & 2	27.0	90.0	10.8	34.4	mV
T _C V _R	Output voltage temperature coefficient (See note (b))	1 & 2	15.0	50.0	15.0	50.0	ppm/°C

ELECTRICAL CHARACTERISTICS (at T_{amb} = 25°C unless otherwise stated)

SYMBOL	PARAMETER	CONDITIONS	MIN.	TYP.	MAX.	UNIT
V _R	Output voltage	I _R =500μA	9.70	9.80	9.90	V
	1% tolerance (A1,C1)					
	2% tolerance (C2)		9.60	9.80	10.00	V
ΔV _{TRIM}	Output voltage adjustment range	R _T =100kΩ		±5		%
T _C ΔV _{TRIM}	Change in T _C V _R with output adjustment			5.0		ppm/°C/%
I _R	Operating current range	See note (c)	0.15		30	mA
t _{on} t _{off}	Turn-on time Turn-off time	R _L =1kΩ		400 0.3		μs
e _{np-p}	Output voltage noise (over the range 0.1 to 10Hz)	Peak to peak measurement		50		μV
R _S	Slope resistance	I _R = 0.5mA to 5mA See note (d)		1.8	4.0	Ω

TYPICAL CHARACTERISTICS

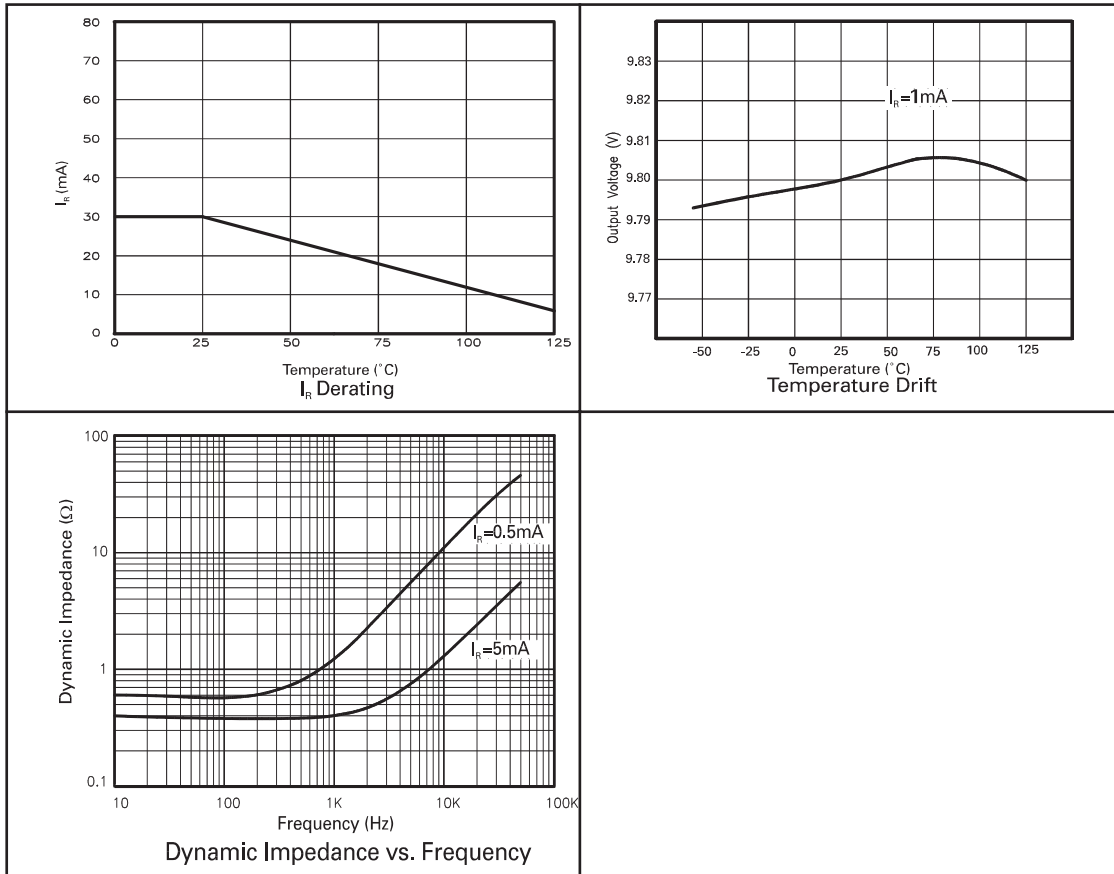

NOTES:

(a) Output change with temperature

The absolute maximum difference between the maximum output voltage and the minimum output voltage over the specified temperature range:

$$\Delta V_R = V_{max} - V_{min}$$

(b) Output temperature coefficient ($T_C V_R$)

The ratio of the output change with temperature to the specified temperature range expressed in ppm/ $^{\circ}$ C:

$$T_C V_R = \frac{\Delta V_R \times 10^6}{V_R \times \Delta T} \text{ ppm}/^{\circ}\text{C}$$

ΔT = Full temperature range

(c) Operating current (I_r)

Maximum operating current must be derated as indicated in maximum ratings.

(d) Slope resistance (R_s)

The slope resistance is defined as:

$$R_s = \frac{\text{change in } V_R}{\text{specific current range}}$$

$$\Delta I = 5 - 0.5 = 4.5 \text{ mA (typically)}$$

(e) Line regulation

The ratio of change in output voltage to the change in input voltage producing it:

$$\frac{R_s \times 100}{V_R \times R_{SOURCE}} \% / V$$

ZRT100

SCHEMATIC DIAGRAM

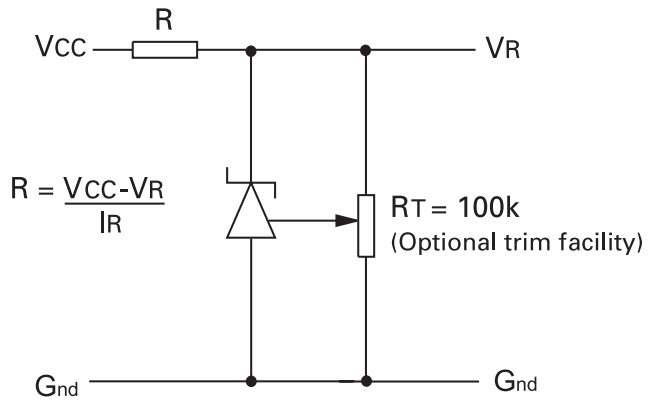
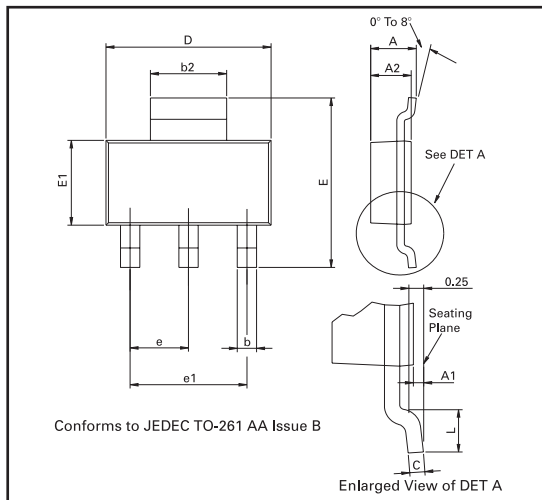

Figure 1:
This circuit will allow the reference to be trimmed over a wide range. The device is specified over a $\pm 5\%$ trim range.

ZRT100

PACKAGE OUTLINE



Controlling dimensions are in millimeters. Approximate conversions are given in inches

PACKAGE DIMENSIONS

DIM	Millimeters		Inches		DIM	Millimeters		Inches	
	Min	Max	Min	Max		Min	Max	Min	Max
A	-	1.80	-	0.071	e	2.30 BSC		0.0905 BSC	
A1	0.02	0.10	0.0008	0.004	e1	4.60 BSC		0.181 BSC	
b	0.66	0.84	0.026	0.033	E	6.70	7.30	0.264	0.287
b2	2.90	3.10	0.114	0.122	E1	3.30	3.70	0.130	0.146
C	0.23	0.33	0.009	0.013	L	0.90	-	0.0355	-
D	6.30	6.70	0.248	0.264		-	-	-	-

© Zetex plc 2003

Europe

Zetex plc
Fields New Road
Chadderton
Oldham, OL9 8NP
United Kingdom
Telephone: (44) 161 622 4444
Fax: (44) 161 622 4446
hq@zetex.com

Zetex GmbH
Streitfeldstraße 19
D-81673 München
Germany
Telefon: (49) 89 45 49 49 0
Fax: (49) 89 45 49 49 49
europe.sales@zetex.com

Americas

Zetex Inc
700 Veterans Memorial Hwy
Hauppauge, NY 11788
USA
Telephone: (1) 631 360 2222
Fax: (1) 631 360 8222
usa.sales@zetex.com

Asia Pacific

Zetex (Asia) Ltd
3701-04 Metroplaza Tower 1
Hing Fong Road
Kwai Fong
Hong Kong
Telephone: (852) 26100 611
Fax: (852) 24250 494
asia.sales@zetex.com

These offices are supported by agents and distributors in major countries world-wide.

This publication is issued to provide outline information only which (unless agreed by the Company in writing) may not be used, applied or reproduced for any purpose or form part of any order or contract or be regarded as a representation relating to the products or services concerned. The Company reserves the right to alter without notice the specification, design, price or conditions of supply of any product or service.

For the latest product information, log on to www.zetex.com

ISSUE 3 - DECEMBER 2003